

Connector

PowerTOP Xtra R

Part Number: 14642



MENNEKES

Elektrotechnik GmbH & Co. KG
Aloys-Mennekes-Straße 1
57399 KIRCHHUNDEM GERMANY
www.MENNEKES.org

Product Description

- screw connection technology ErgoCONTACT
- X-CONTACT
- highly heat resistant contact carrier
- nickel plated contacts
- ergonomic enclosure design with nubbed grip areas
- rubberised cable gland with sealing
- rubberised bayonet ring
- sealed against dust, temporary submersion and high pressure cleaning
- strain relief and protection against kinking
- thread lock and safety slide
- area for self-adhesive labels

Technical Details

Connector - PowerTOP Xtra R	14642
Product series	PowerTOP Xtra R
Ampere	16 A
UL-Ampere	-
Number of Poles	5 P
Clock position	9 h
Voltage	230 V
Hertz	50-60 Hz
Current Type	AC
Protection Type	IP67
Contact carrier	Nickel-plated contacts Highly heat resistant X-CONTACT®
Pilot contact	Without pilot contact
Connection	Screw terminals - ErgoCONTACT®
Screw drive contact screw	Combination head screw (PZ2 and slotted)

Conductor cross-section min.	1 mm ²
Conductor cross-section max.	2.5 mm ²
Cable kink protection	Integrated in cable gland
Protective grommet	Without protective grommet
EAN / Identification number	4015394306030

Permissible ambient conditions

Permanent ambient temperature min. - max.	-25 °C - +40 °C
---	-----------------

Material properties

Hinged lid	PC similar RAL 5017 blue
Cover	PA6 similar RAL 7000 grey
Front part	PA6 similar RAL 5017 blue

Material resistance

The material resistance overview can be found on the website in the section "Knowledge" → "Product knowledge" → "Materials"

Regulations and Standards

REACH (Regulation (EG) No. 1907/2006)	Information according to article 33 REACH: SVHC: Lead (CAS: 7439-92-1)
RoHS 2011/65/EU incl. 2015/863/EU	✓
POP Regulation (EU) 2019/1021	✓
Norm(s)	IEC 60309-2
Declaration of conformity	CE

Dimensional drawing

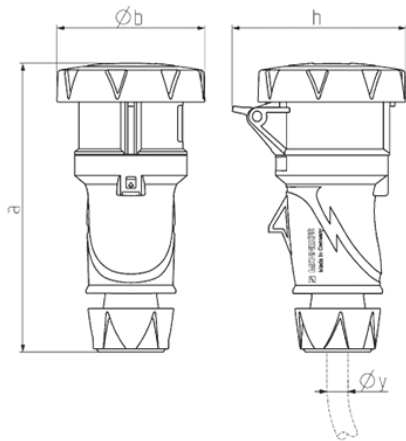

Drawing	Amp. Poles	16			32		
		3	4	5	3	4	5
3 MB 82							
Dim. in mm	a	167	177	179	213	213	214
	b	73	82	89	97	97	103
	h	89	99	105	109	109	115
y min. from		7	8	8	10.5	10.5	13.5
to max. mm		-13	-15.5	-15.5	-18	-18	-20
Terminal for cond. cross		1	1	1	2.5	2.5	2.5
section (mm²) min.-max.		-2.5	-2.5	-2.5	-6	-6	-6