

Protective cover

Part no. 40787

- for watertight plugs, wall mounted and panel mounted inlets



Technical specifications

Ampere	63 A
Poles	5 p
Weight	107 g

Drawing

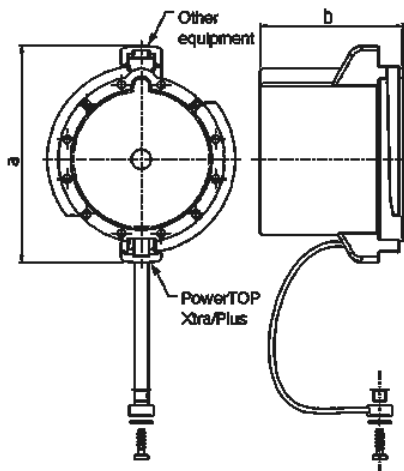

Drawing	Amp.	63			125		
		3	4	5	3	4	5
2 MB 239	Poles						
Dim. in mm	a		110			120	
	b		73			79	